

CHEYENNE PLATFORM BED - FULL / QUEEN

ASSEMBLY INSTRUCTIONS

STEP# 1 (SEE #1 ILLUSTRATION)

- INSERT DOWEL IN END OF SIDE RAIL AND INSERT INTO POST. ATTACH SIDE RAIL TO THE FOOT BOARD , USING THE LONG BOLTS AND CRESCENT NUTS. TIGHTEN WITH ALLEN WRENCH. REPEAT FOR OTHER SIDE RAIL. ASSEMBLE THE FOOT BOARD TO BOTH ENDS OF THE SIDE RAILS USING THE LONG BOLTS AND CRESCENT NUTS, TIGHTEN WITH ALLEN WRENCH.

STEP# 2 (SEE #2 ILLUSTRATION)





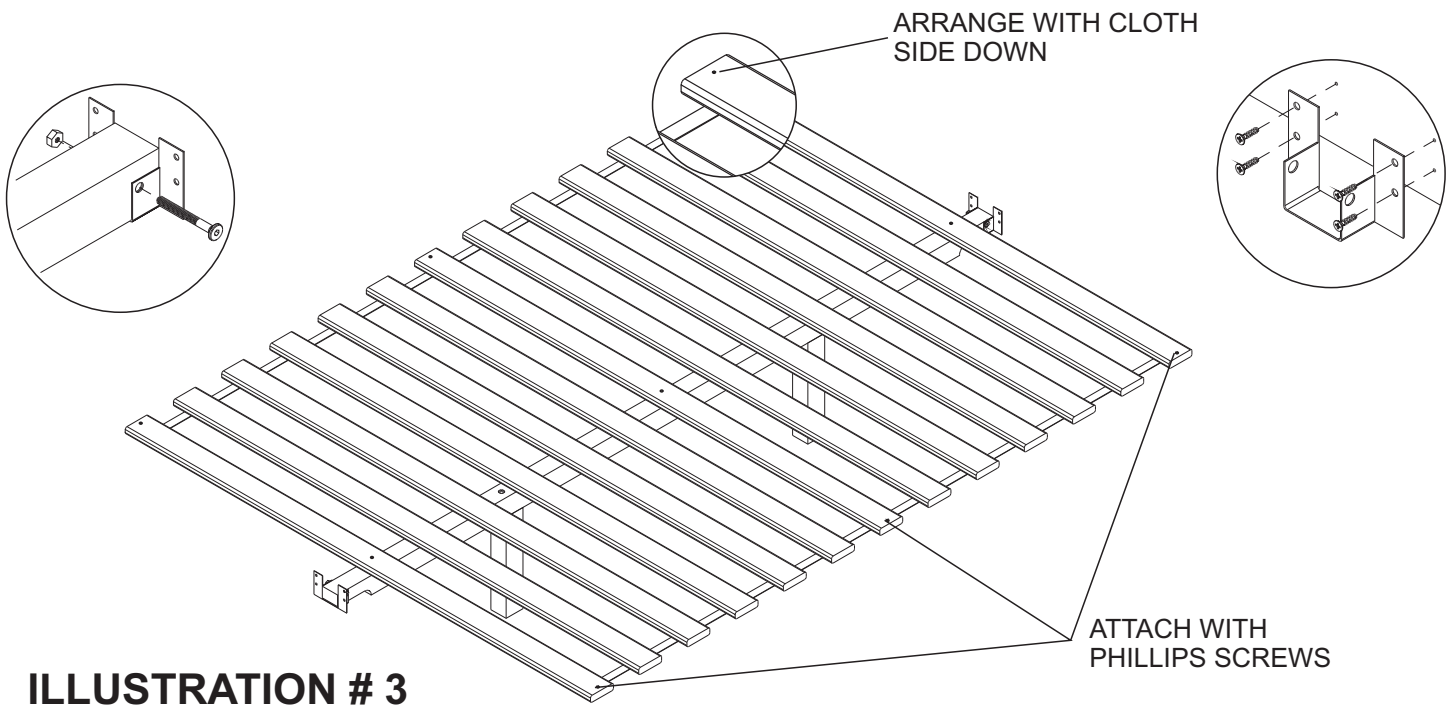
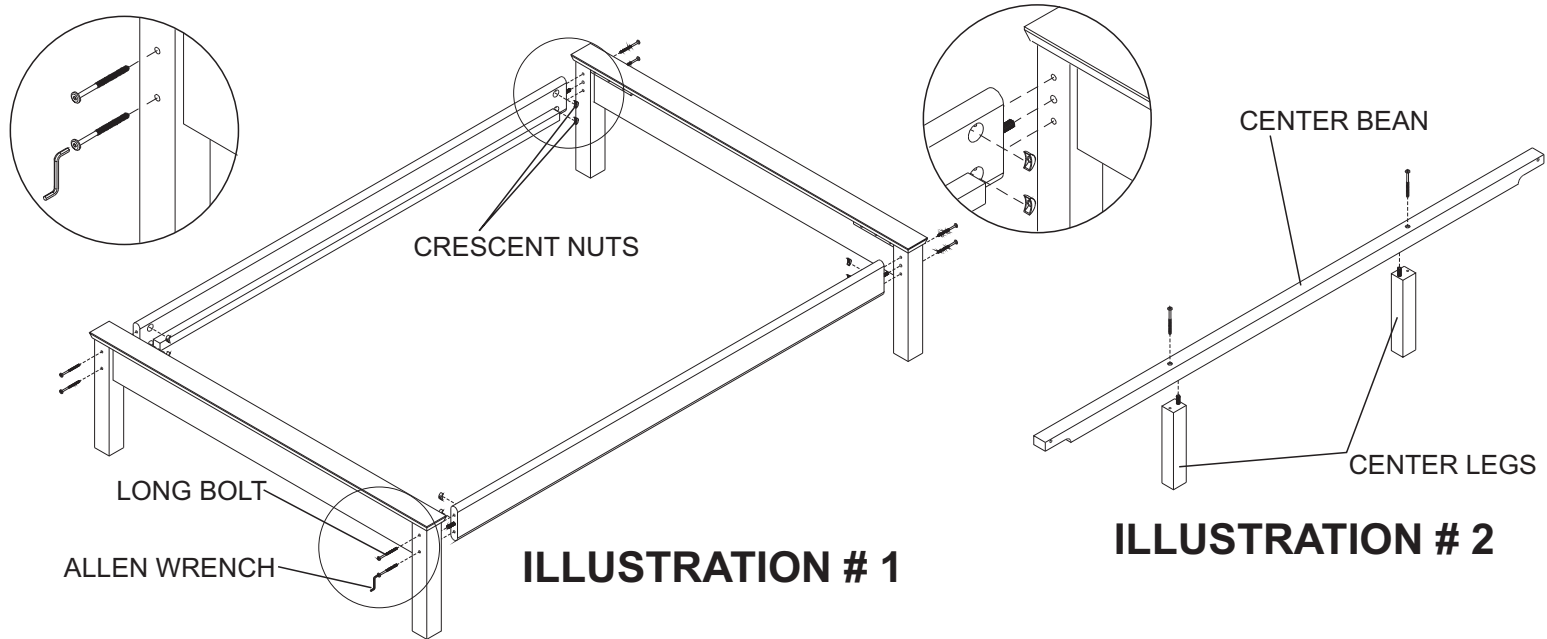

- ATTACH METAL BRACKET OPEN END UP IN CENTER OF FOOT BOARD AND HEAD BOARD WITH FOUR PHILLIPS SCREWS. INSERT CENTER SUPPORT BEAM INTO BRACKET AND BOLT AT EACH END. THE CENTER LEGS, ATTACH WITH DOWEL AND LAG SCREW TO THE CENTER BEAM. NOTE THE LEGS DO NOT TOUCH THE FLOOR.
- ALWAYS LIFT THE BED TO MOVE IT, DRAGGING MAY BREAK CENTER LEG.

STEP# 3 (SEE #3 ILLUSTRATION)



- CAREFULLY LAY OUT THE SLAT KIT, LOCATE THE FIRST AND LAST SLAT TO THE BEGINNING OF THE CLEAT, ATTACH WITH PHILLIPS SCREWS TO THE FIRST LAST AND MIDDLE SLATS DO THE SAME FOR CENTER BEAM,

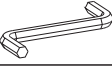
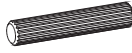
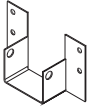
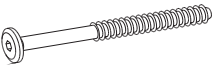

HARDWARE LIST CHEYENNE PLATFORM BED FULL / QUEEN

	1/4"x100	LONG BOLT TO ATTACH FOOT BOARD AND HEADBOARD TO THE SIDE RAILS	8PCS
		CRESCENT NUT FOR THE LONG BOLTS	8PCS
	1/4"x60	BOLT AND NUT TO ATTACH METAL BRACKET TO THE CENTER MOUNTED BEAM.	2PCS
	3,5x30	PHILLIPS SCREW TO ATTACH SLATS TO SIDE RAILS AND CENTER MOUNTED BEAM.	09PCS
		ALLEN WRENCH	1PCS
	10x40	DOWELS THAT GO IN THE ENDS OF SIDE RAILS.	6PCS
		METAL BRACKET TO ATTACH CENTER BEAM	2PCS
		LAG SCREW TO ATTACH LEG TO CENTER BEM	2PCS
	3,5x20	ATTACH METAL BRACKET TO HEAD+FOOT	8PCS

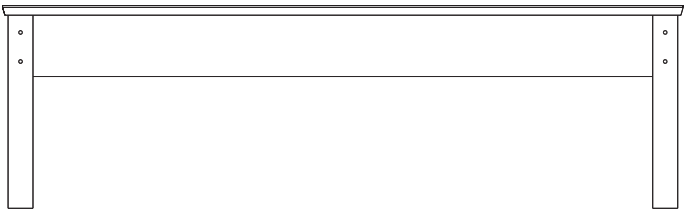
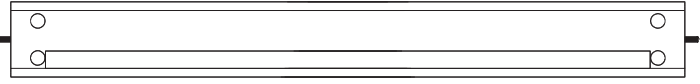
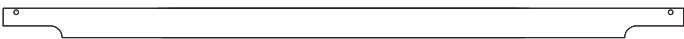
PART LIST

	FOOT BOARDS	2PCS
	SIDE RAILS WITH ATTACHED CLEATS	2PCS
	CENTER BEAM	1PCS
	CENTER LEG FOR CENTER BEAM ATTACH ONE DOWEL, ONE LAG SCREW	2PCS
SEE ILLUSTRATION #3	SLAT KIT	1PCS