

1A One Pair of Shoe Fittings Arms:

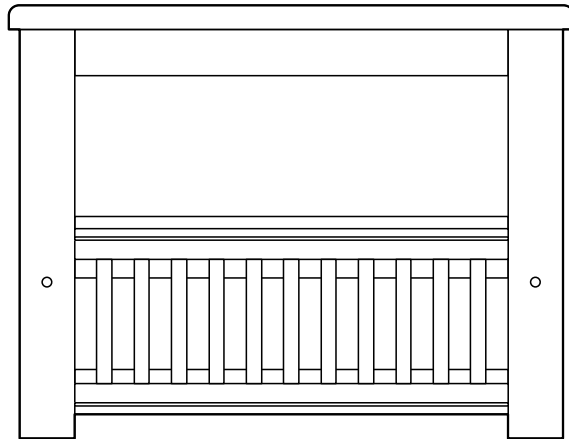

Outside View

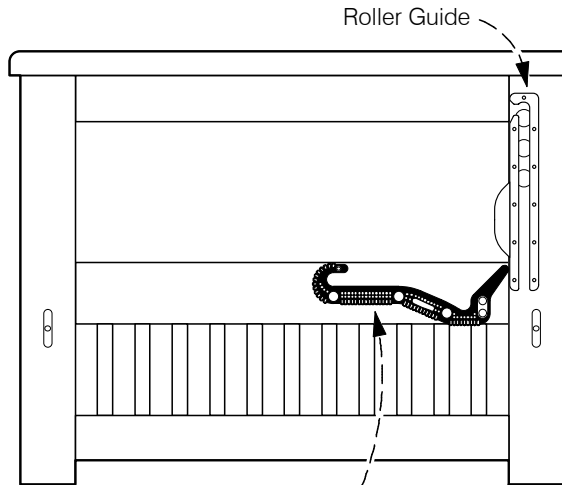

Inside View

Roller Guide

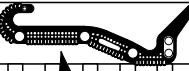

Sea Horse



featuring the Rubber

SEA HORSE™

1B Hardware in this Box:

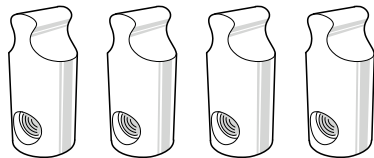

ThumNut™ x 4 pieces
Patent No.: US 6,457,923

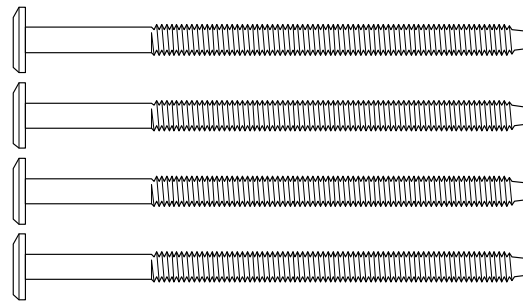

Long Bolts (130mm)
x 4 pieces

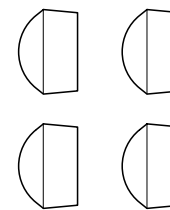

Wood Buttons
x 4 pieces



Allen Key
x 1 piece

2A Attach the Stretchers to the Arms.

Using Long Bolts and ThumNuts™ provided with the Arms, attach the Arms to the Stretchers as shown.

The raised side of the stretcher should face upwards.

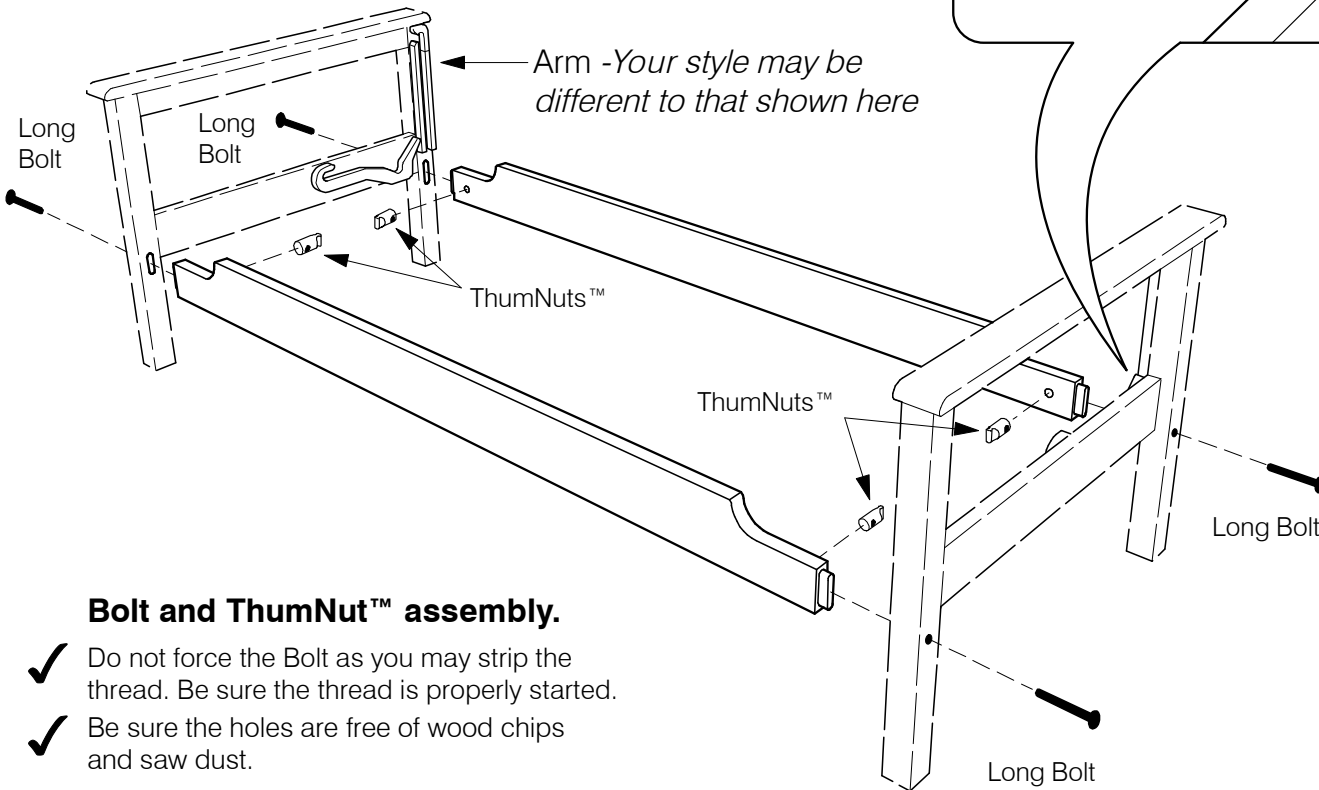
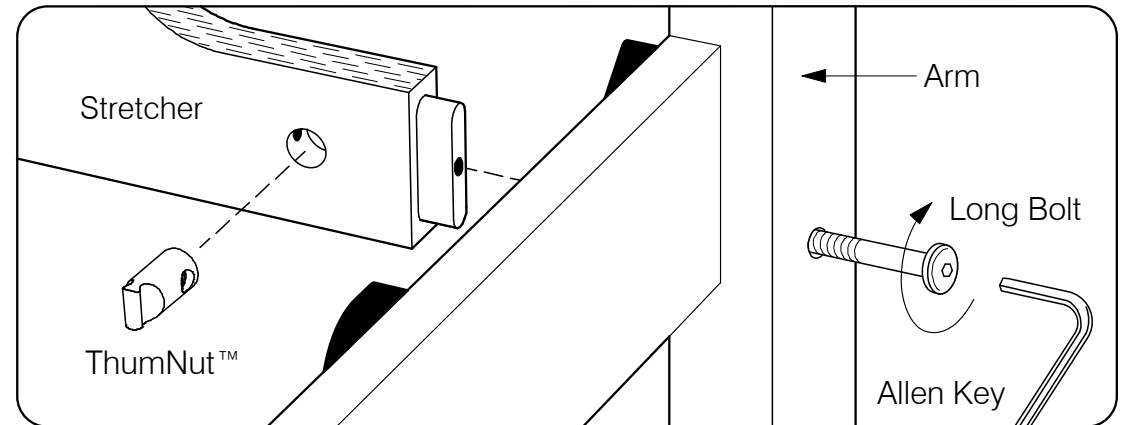
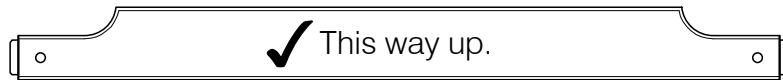

Bolt and ThumNut™ assembly.

- ✓ Do not force the Bolt as you may strip the thread. Be sure the thread is properly started.
- ✓ Be sure the holes are free of wood chips and saw dust.

2B Fit Wood Buttons into Bolt Holes.

Tighten all Bolts. Push fit or lightly tap the Wood Buttons into the Bolt holes on the Arms.

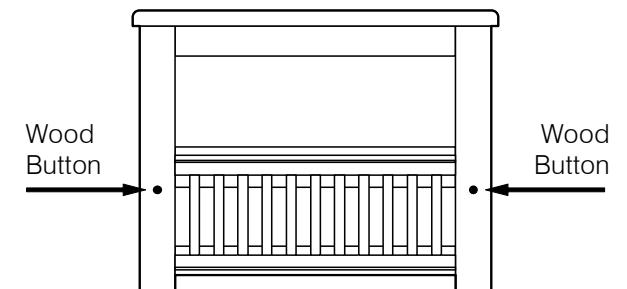

3A Carefully lift the Back Deck into position. Place the Bottom Rollers onto the back of the Rubber Sea Horse.

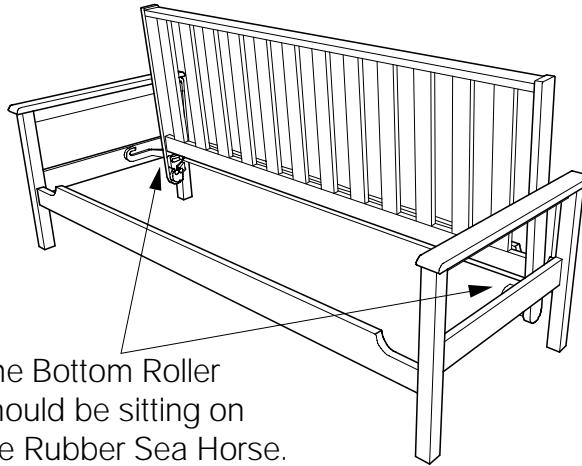
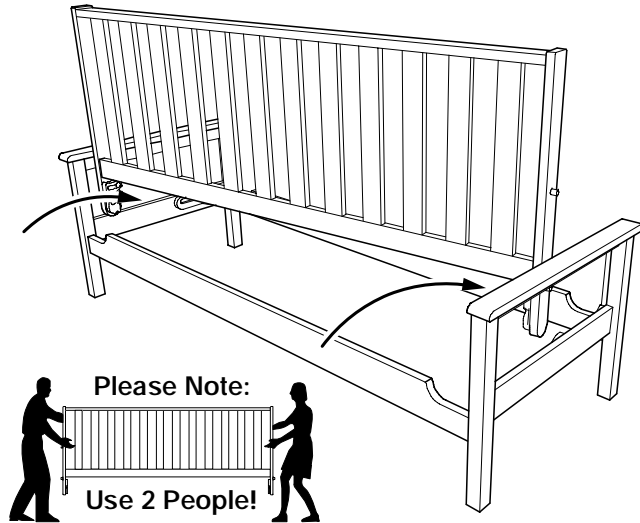

3B Rest the Top Rollers against the Leg.

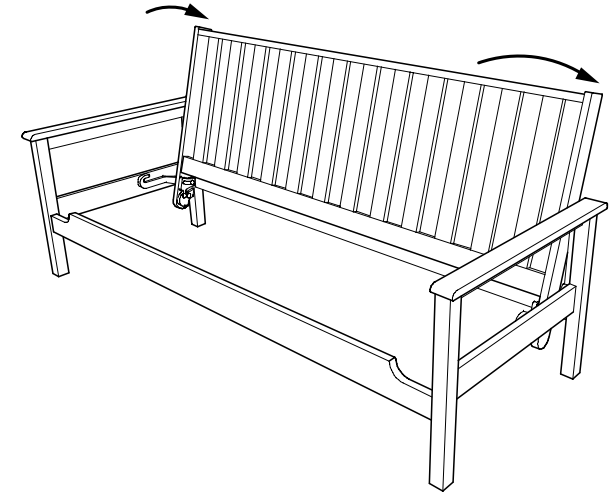

3C Gently lift the Back Deck so the Top Roller goes inside the Roller Guide.

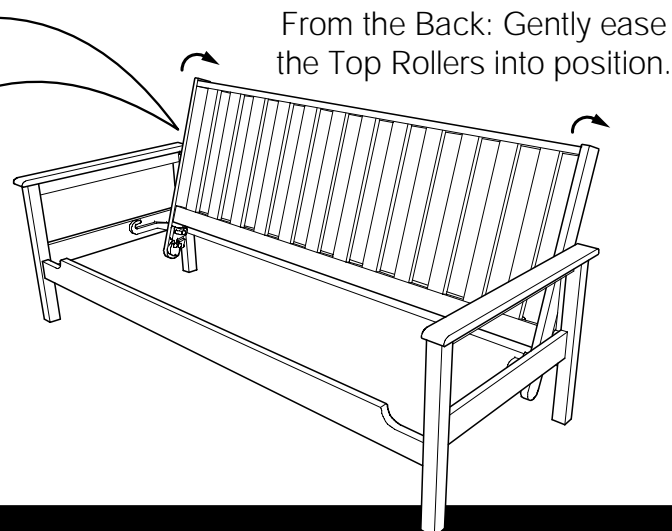
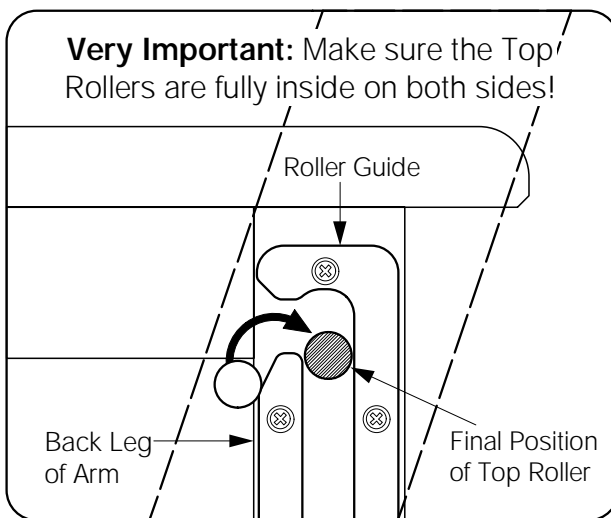

3D Gently Lower the Back down until it is lying flat.

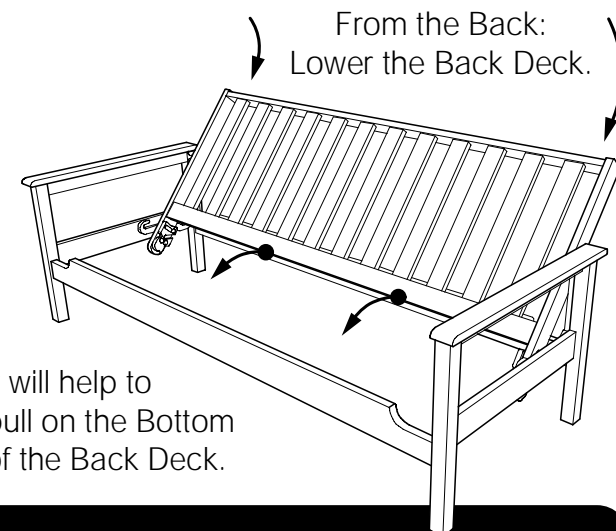

4A Hook the Seat Deck onto the Snapper.

Lift the Seat Deck in vertically, so the Pins meet with the Rubber Snapper. The head of the Snapper should fit **between both Pins**.

Just remember: •The Top Pin - fits over the top,
•The Lower Pin - goes underneath.

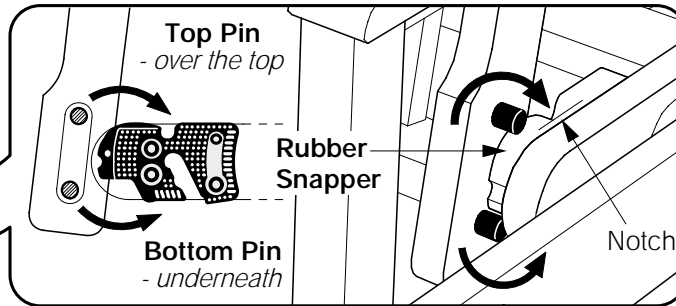
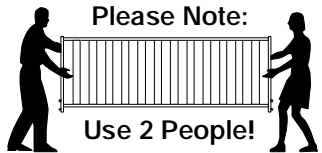
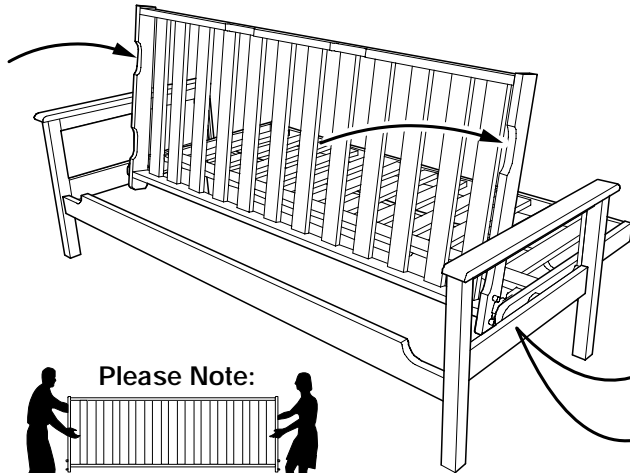

4B Pull the Seat over the "Snap Point."

You will need to Pull Hard.



With the Top Pin **inside the notch** on the Rubber Snapper, put your foot on the Back Deck and pull the Seat over the "Snap Point"

4C Push down on the Seat, and the Back will Lift.

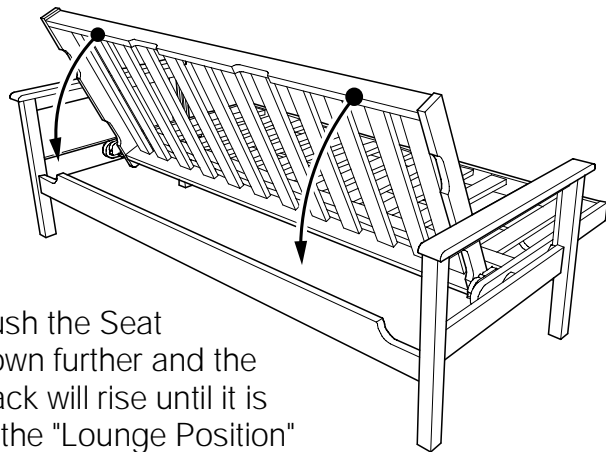

Push the Seat down further and the Back will rise until it is in the "Lounge Position"

4D This is the Lounge Position.

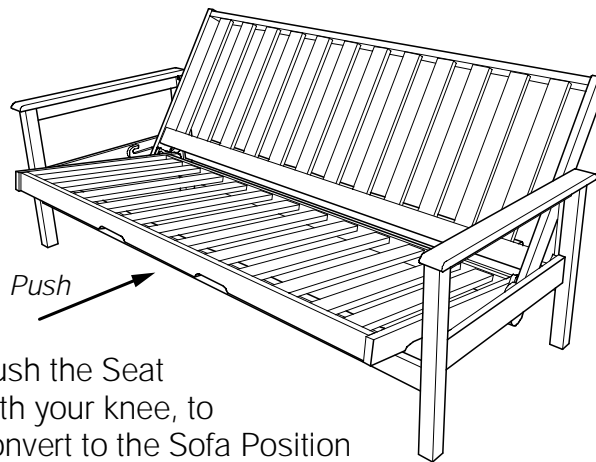

Push the Seat with your knee, to convert to the Sofa Position

4E This is the Sofa Position.



Add Mattress and Enjoy! See separate page for Operating Instructions.

5A From the Bed position, lift the Seat.

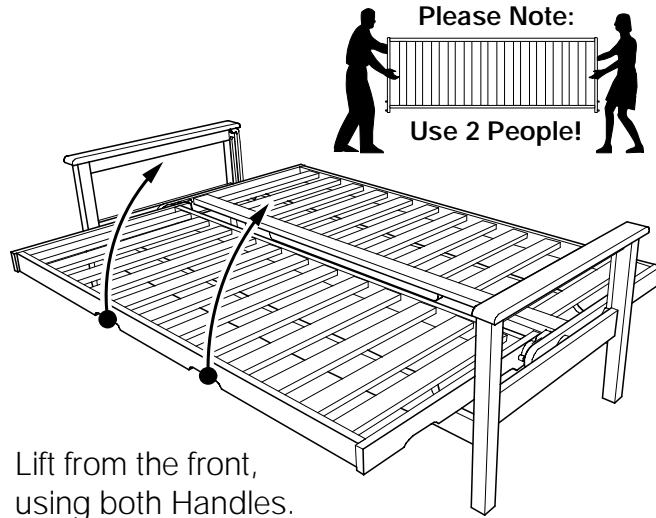

5B Lift the Seat all the way.

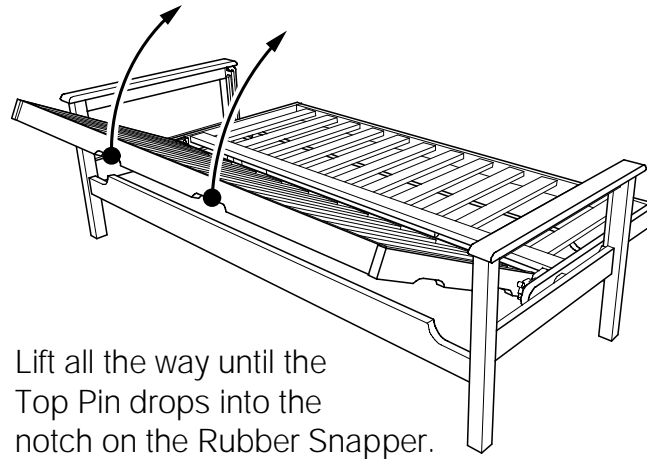

5C Push the Seat over the "Snap Point."

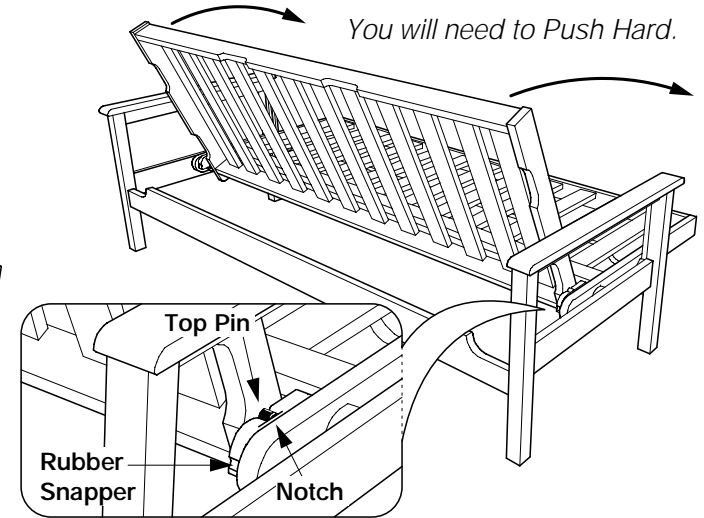

5D From the Back, lift out the Top Pin and ease the Seat Deck forward.

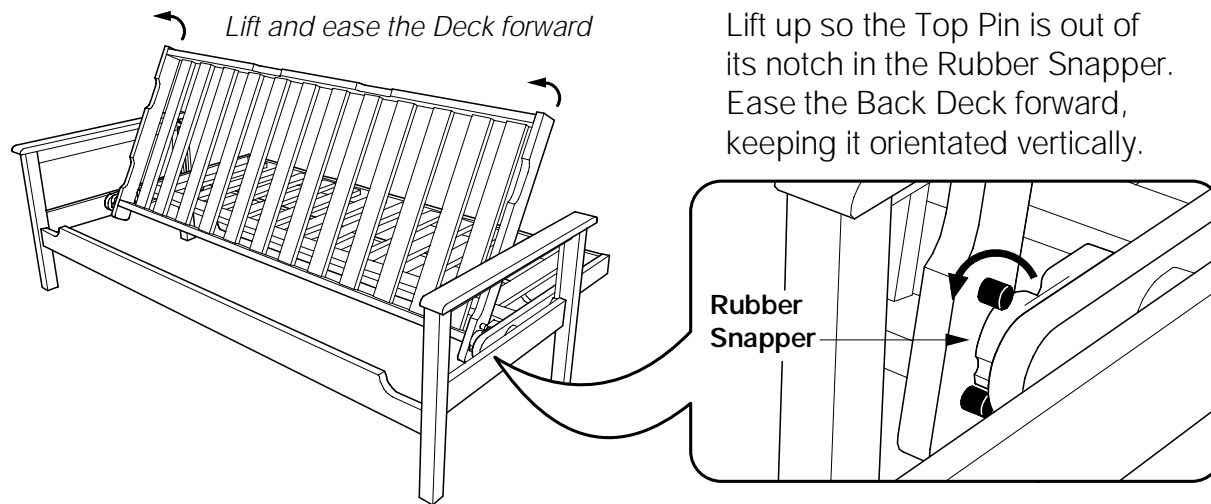

5E Lift the Seat clear of the frame.



6A Lift the Back Deck up.

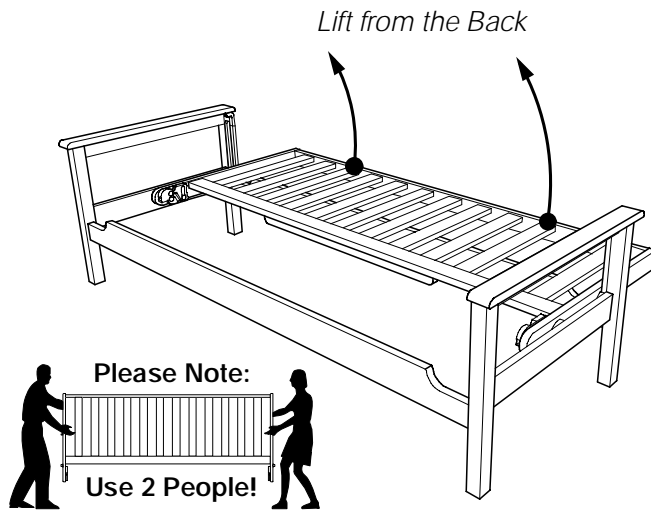

6B Lift Back Deck so the Top Roller is clear of the Back Leg.

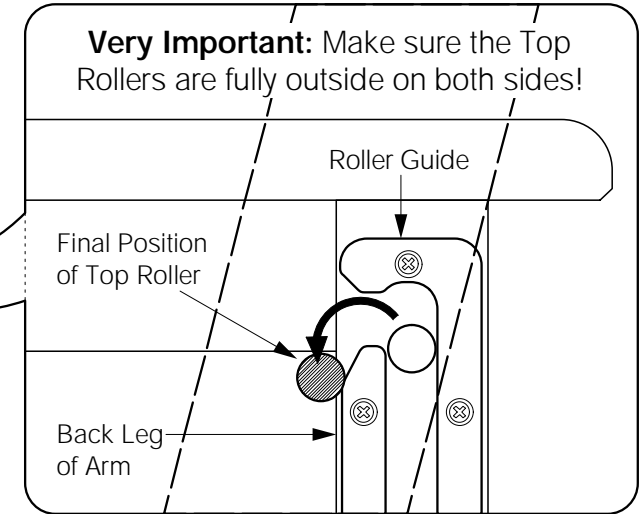
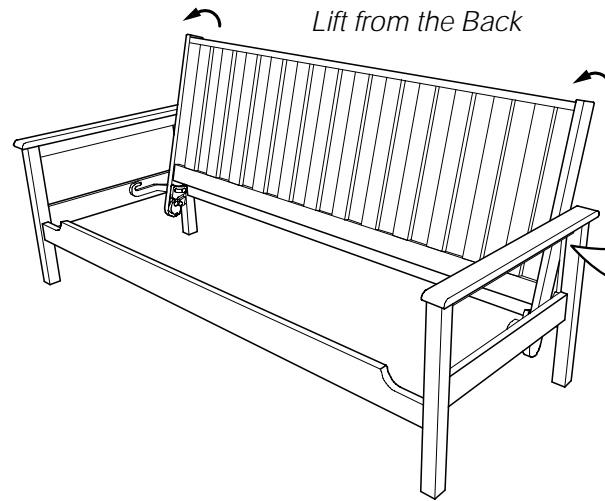

6C Push the Deck forward at the top.

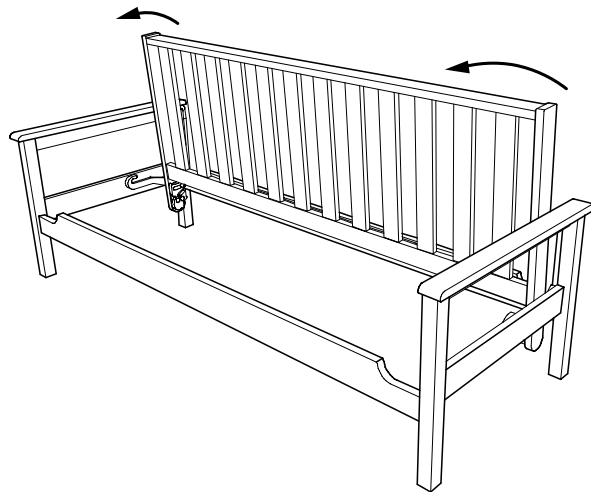

6D Lift the Back away from the Arms.

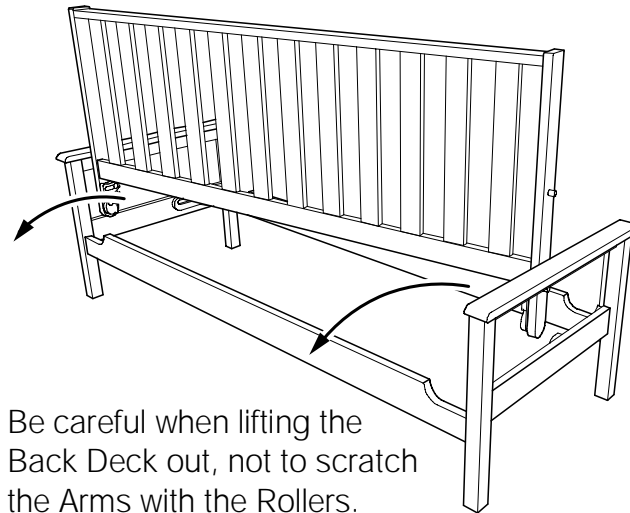

6E Undo the Stretcher Bolts.

