

**CRADLE
CONVERTER
ARM**

MANILA

Bi-Fold Arm Parts List

Please follow Assembly Instructions in Body Box

One Pair of Arms

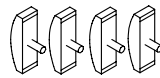
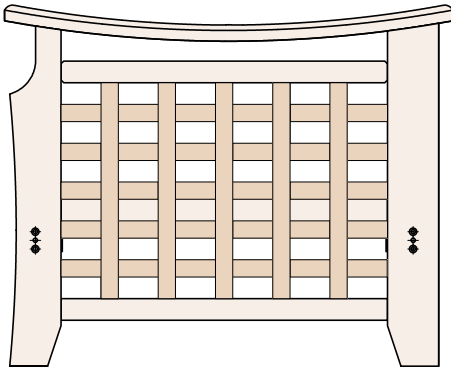

4pcs of Wood Blocks
with Pre-installed dowels.

Install the Wood Blocks to
the Bi-Fold Arms

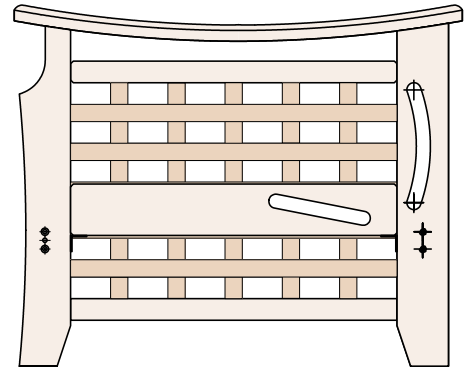

Hardware in this box

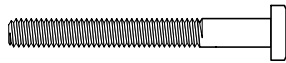

Bolts - 8 Pieces



Barrel Nuts - 8 Pieces

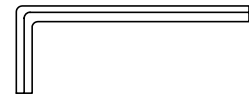

Allen Key - 1 Piece

INSTALLATION OF WOOD BLOCK

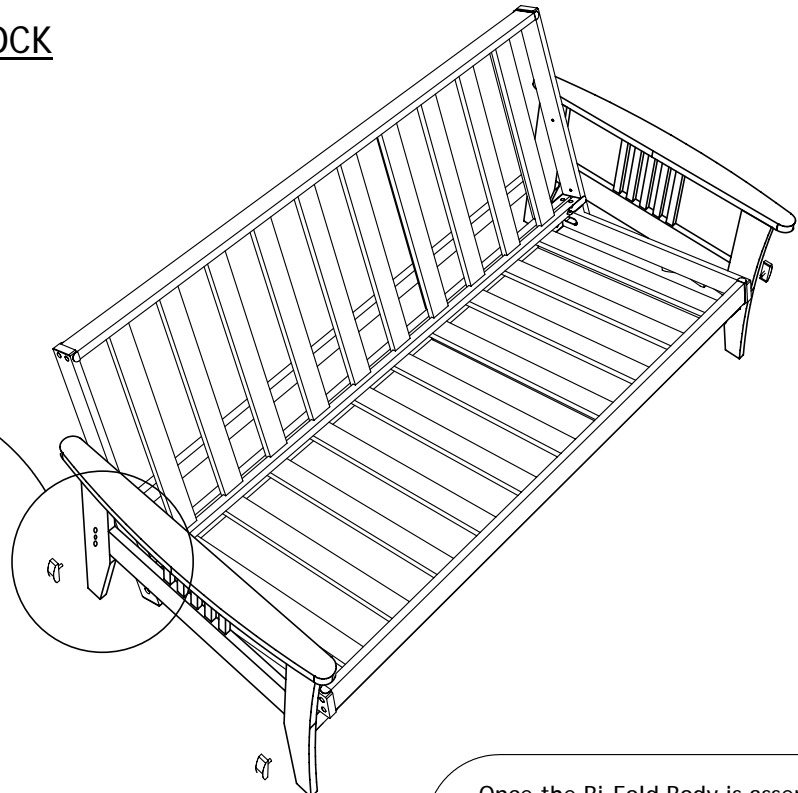
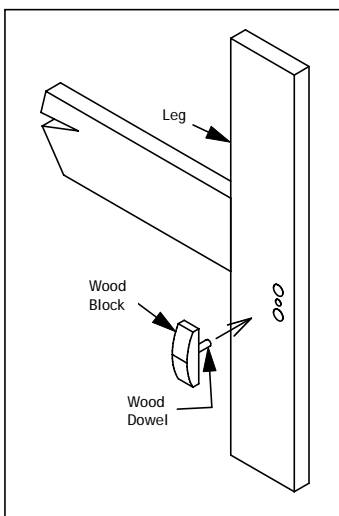

Once the Bi-Fold Body is assembled
to the arms, install the wood blocks
on the arms to cover the bolt holes.



LIFESTYLE SOLUTIONS

The Fusion Of Function And Comfort With Style